

INVESTIGATION ON EFFECT OF WELD YIELD STRENGTH DURING SINGLE POINT INCREMENTAL FORMING OF TAILOR WELDED BLANKS

Shalin Marathe, Harit Raval

Department of Mechanical Engineering, S. V. National Institute of Technology, Surat-395007, Gujarat, India.

Corresponding author: Shalin Marathe, d16me008@med.svnit.ac.in

Abstract: Tailor Welded Blank (TWB) is a product of joining two or more than two materials having different properties or thicknesses prior to any forming process. TWBs offer the advantages like reduction of weight and cost during manufacturing an automobile product. But, TWBs are also associated with the two major limitation of weld line shift and formability reduction during any forming process. However, Single Point Incremental Forming (SPIF) process has resulted in the improved formability of homogeneous blanks. In the present investigation forming of TWBs is done during SPIF process using ABAQUS/Explicit. The effect of weld yield strength on the shift of weld boundary and thinning of parent materials is investigated. It has been found that as the strength of the weld material increases, thinning of the weak material present in the TWB increases resulting in to the more shift in the weld boundary between weak and weld material. The low strength weld material will deform more during forming that will lead to change the width of the weld material resulting in to the shift of boundary between weld and base materials.

Key words: Tailor Welded Blanks, Single Point Incremental Forming, Weld line shift, ABAQUS/Explicit, %thinning, Forming force.

1. INTRODUCTION

The automobile industries are putting so much efforts to make products more fuel efficient and low in cost. These two demands are very crucial and it is offered by one technology called Tailor Welded Blank (TWB). The fabrication of TWBs involves joining of materials having different thicknesses, properties and coatings. After joining the blanks, forming is done on the TWBs to achieve the desired shape. Two different material having different properties and thickness will deform differently under the same loading conditions. The weak/thin material will experience more deformation in comparison to the strong/thick material during forming operation. Because of this uneven deformation, weld line will experience a push towards strong/thick material resulting in to the weld line shift which is a major limitation of TWB (Suresh et al., 2016). The weld line shift is observed towards

the strong/thick material side during conventional forming processes (Suresh et al., 2016, Parente et al., 2016) but for SPIF process this weld line shift is towards both side of the weld line (Marathe and Raval, 2019). The mechanism of SPIF process involves gradual and small deformation with the help of a small spherical or hemispherical tool on the blank being formed (see Figure 1). The small contact area between tool and the blank being formed result in to the tool dragging force due to tool movement with respect to blank which is responsible for weld line shift towards both side of weld line (Marathe and Raval, 2019).

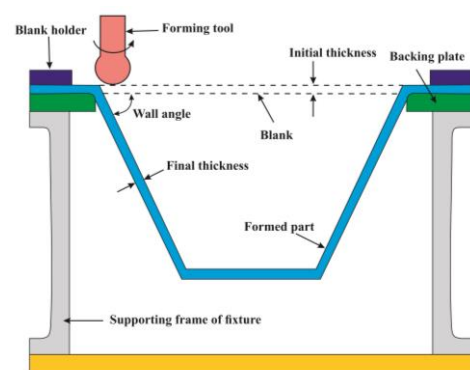

Fig. 1. Basic working principle of SPIF process

The gradual and localised deformation mechanism of SPIF process results in to the improved formability of homogeneous blank in comparison to the conventional forming processes (Martins et al., 2008). The combination of SPIF process with TWBs was attempted by few researchers and it was found that this combination is capable of solving problem of weld line shift and low formability of TWBs (Alinaghian et al., 2017, Tayebi et al. 2019, Silva et al., 2009, Rattanachan et al., 2014). However, this combination demands for in depth investigation dealing with effect of process parameters and material properties on forming behaviour of TWBs. In the present investigation, simulation of SPIF process is done to form the TWBs. Effect of strength of weld material on weld line shift during forming

process in investigated. ABAQUS/Explicit is used as the simulation tool and effect of friction during the forming process on weld line shift is also studied in the present investigation.

2. SIMULATION CONDITIONS

2.1 Material Properties

The aim of the present work is to check the effect of weld yield strength on weld line shift during SPIF process. The properties of base metals like density, young’s modulus, poissons ratio, strength coefficient and strain hardening index were kept constant and the properties of Weld Metal (WM) were selected average of properties of base metals (Arfa et al., 2013). The yield strengths of Base Metal -1 (BM-1) and Base Metal -2 (BM-2) were kept constant but the yield strength of weld metal was only varied as tabulated in Table 1. The BM-1 is AA 6061 T6 and BM-2 is AA 5083-O. For simulation number 1, the label “ES-260” stands for “Effect of Strength” and in this case the strength of the weld material is 260. This notation is applicable to all simulation run. The yield strength of BM-1 (AA 6061 T6) is higher than BM-2 (AA 5083-O) hence BM-1 material is considered as Strong BM and BM-2 is considered as Weak BM now onwards.

For all the simulation weld line shift and thinning of the blank is studied and compared with each other.

Table 1. Change of yield strength of Weld Metal (WM) for simulation

Simulation No.	Yield Strength (MPa)			Label of the simulation
	BM-1 AA 6061 T6	BM-2 AA 5083-O	WM	
1	280	150	260	ES-260
2	280	150	240	ES-240
3	280	150	220	ES-220
4	280	150	200	ES-200
5	280	150	180	ES-180
6	280	150	160	ES-160

2.2 Modelling of Parts

In ABAQUS/Explicit module, hemispherical rigid tool and deformable blanks were modelled as shown in Figure 2. The forming tool radius was 6 mm (Ambrogio et al., 2007, Silva et al., 2011) and the blank dimension was 70 mm × 70 mm. The weld metal properties were incorporated using “Weld Zone” approach during the simulation (Zadpoor et al., 2007). Weld zone was modelled at the centre of the blank and separate properties were allocated to it during the material property definition module of the ABAQUS/Explicit. The width of weld zone was 8 mm and thickness of 1 mm.

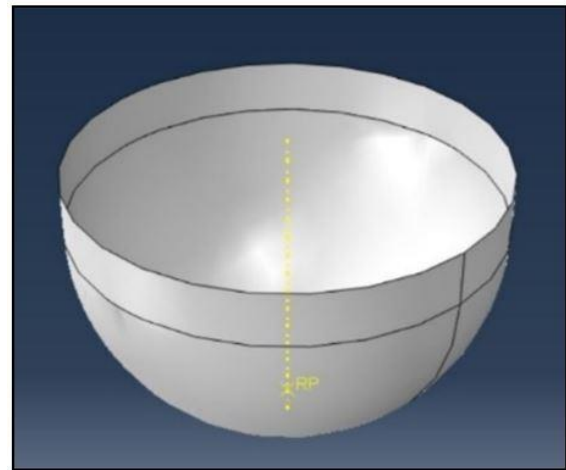

(a)

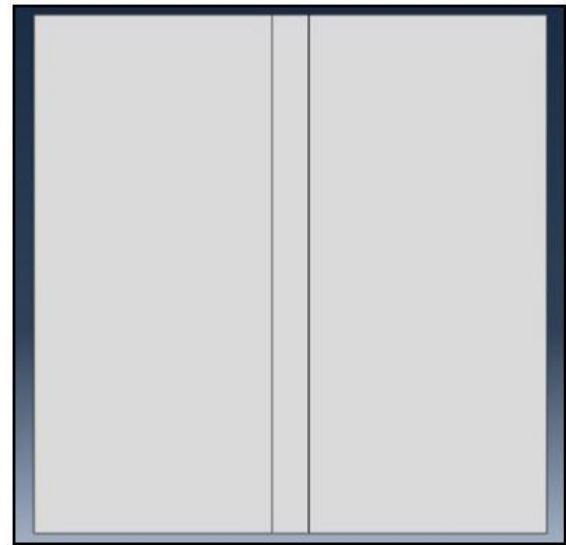

(b)

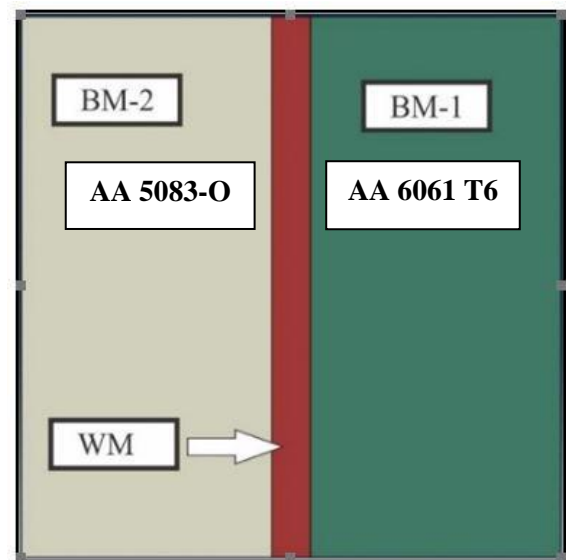

(c)

Fig. 2. Tool and blank used in the simulation study: (a) Hemispherical rigid tool; (b) Deformable blank; (c) Assignment of material properties in weld zone approach (Zadpoor et al., 2007)

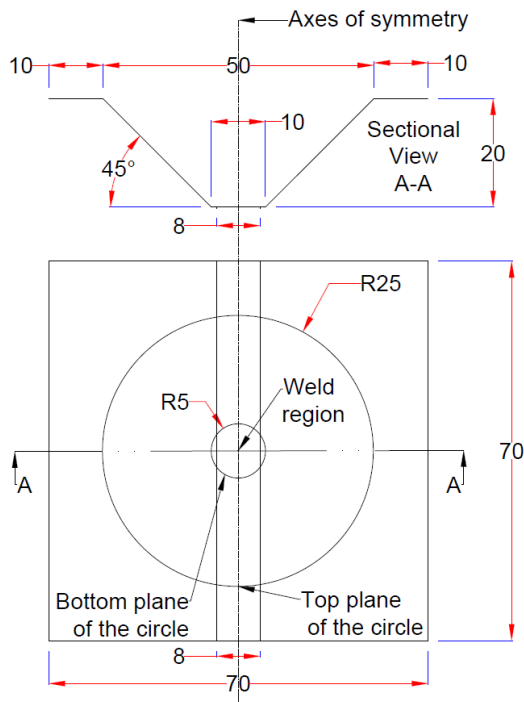

Fig. 3. Target geometry (truncated cone)

The welded blanks were converted in to target geometry of truncated cone as shown in Figure 3. To achieve the desired geometry, contour tool path strategy was selected in which tool completes circular planner movement and deforms the blank after each pass (see Figure 4). The value of step over and step down depends upon the target geometry to be achieved during forming process.

2.3 SPIF Process Parameters

In the present simulation work SPIF process parameters were kept constant as tabulated in Table 2. The forming of TWBs using SPIF process results in to four different positions of the forming tool as explained by Marathe and Raval, 2019. Four different positions of forming tool are SC (Strong Centre), WC (Weak Centre) and WTS (Weld-To-Strong) and WTW (Weld-To-Weak) as reported by Marathe and Raval, 2019. It was found that WTS results in to the least amount of weld line shift hence in the present work WTS initial position of tool was considered.

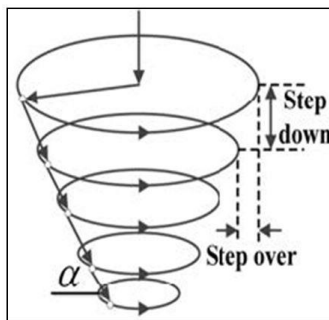

Fig. 4. Contour tool path strategy (α = wall angle) (Desai et al., 2014)

Table 2. Process parameters of SPIF

Sr. No.	Parameter	Unit	Value
1	Forming tool radius (Ambrogio et al., 2007, Silva et al., 2011)	mm	6
2	Coefficient of friction between tool and blank (Zhang et al., 2010, Kumar and Reddy, 2016)	-	0.1
3	Incremental depth (Desai et al., 2017, Desai et al., 2014, Bansal et al., 2017)	mm	0.5
4	Tool travel speed (Dakhli et al., 2019, Kilani et al., 2020)	mm/sec	15
5	Tool rotational speed (Centeno et al., 2014)	RPM	1000
6	Tool initial position (Marathe and Raval, 2019)	-	WTS

3. RESULTS AND DISCUSSION

3.1 Formed Geometry

The formed geometry is shown in Figure 5. The shift in the weld line can be observed in top view (Figure 5 (a)) and side view (Figure 5 (b)) of the formed geometry. TWB consist of two different parent materials and one weld material. These three materials have different mechanical properties and hence their deformation under same loading conditions will be different. In addition to that, in SPIF process, tool dragging plays an important role in wild line shift (Marathe and Raval, 2019). The detailed analysis is reported in the next section.

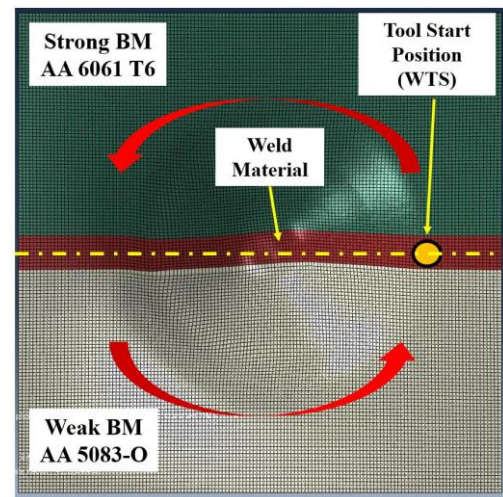

(a)

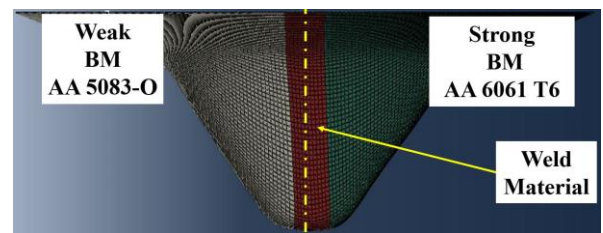

(b)

Fig. 5. TWBs formed in to truncated cone: (a) Top view; (b) Side view

3.2 Weld Line Shift and Thinning

The weld line shift during forming of TWBs is observed due to the properties and thickness difference between the parent blanks. The detailed analysis of weld line shift for ES-160 condition is shown in Figure 6. The shift of weld line can be divided into two sections namely A and B. In section A, the weld line shift is less and towards weak material while in section B, the shift of weld line is towards strong material and the shift is more in comparison to the section A. Due to the contact and friction between forming tool and blank being formed, tool dragging takes place. During forming, weak material will deform more in comparison to the strong material. Hence that will try to push the weld line towards strong material. In section A, the tool dragging and deformation of weak material are opposite to each other. The effect of tool dragging is more in comparison to the deformation of weak material. Hence, in section A, shift of weld line is less and it is towards weak material while in section B, weld line shift is more and towards strong material. Figure 6 also indicates that there is shift in the strong-weld material boundary and weak-weld material boundary. This shift in the boundary is due to the deformation of weld and weak material. As the yield strength of the weld material increases the deformation experienced by the weld material decreases because the majority of the deformation is shared by the weak material. Similarly, when the yield strength of the weld material is low, weld material will experience more deformation than weak material. This deformation of weak and weld material will lead to shift in strong-weld and weak-weld boundary. The comparison of shift of weld line

between ES-160 and ES-260 conditions is represented in Figure 7.

Figure 7 shows that the shift of boundary between strong-weld and weak-weld material for ES-160 and ES-260 cases. The shift of boundary between weld and weak material is more for ES-260 in comparison to the ES-160 condition. As the strength of the weld material increases, in the entire TWB, weak material becomes weaker resulting in to more deformation of weak material. Hence, more shift of boundary between weak and weld material is observed in ES-260 case.

In ES-160 condition, the shift of boundary between strong and weld material is more in comparison to the ES-260 case. In ES-160 case, the deformation of weld material is more in comparison to the ES-260 case. Hence, the boundary between strong and weld material shifts more in ES-160 case in comparison to the ES-260 case. Similar kind of results are observed for shift in weak-weld boundary and strong-weld boundary as depicted in Figure 8 and 9 respectively. The maximum shift of boundary is observed in the wall region of the cup between distance of 35-45 because there is no tool dragging to oppose the deformation of weak material (see Figure 8 and 9).

As the yield strength of weld material decreases, more deformation is experienced by weld material and therefore the width of weld material changes during forming process. The change of weld width for ES-160 and ES-260 case depicted in figure 10. The original weld width is 8 mm and after forming the weld width changes during forming and the maximum weld width is found for ES-160 case of 9.10 mm.

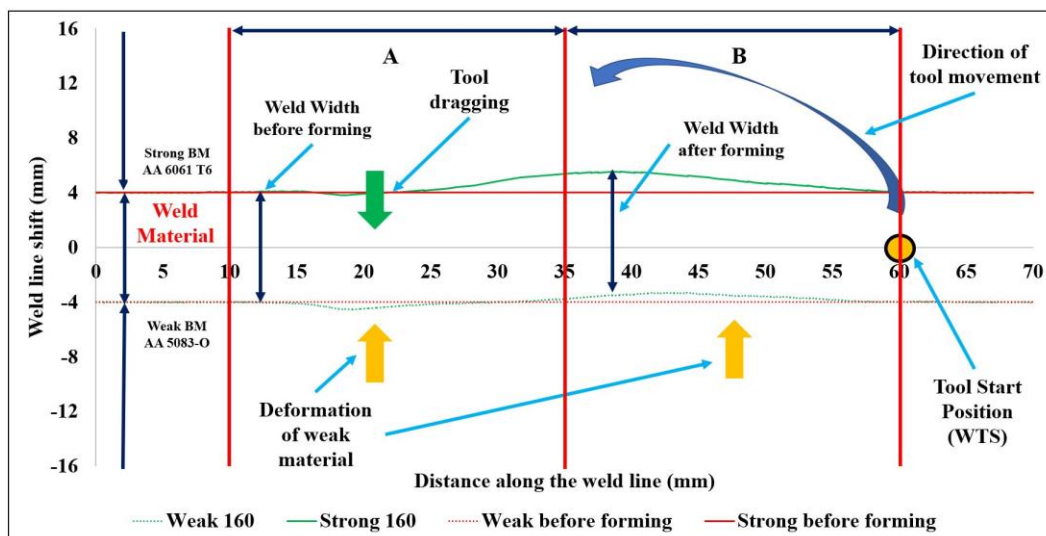

Fig. 6. Deformation in weld material for ES-160 condition

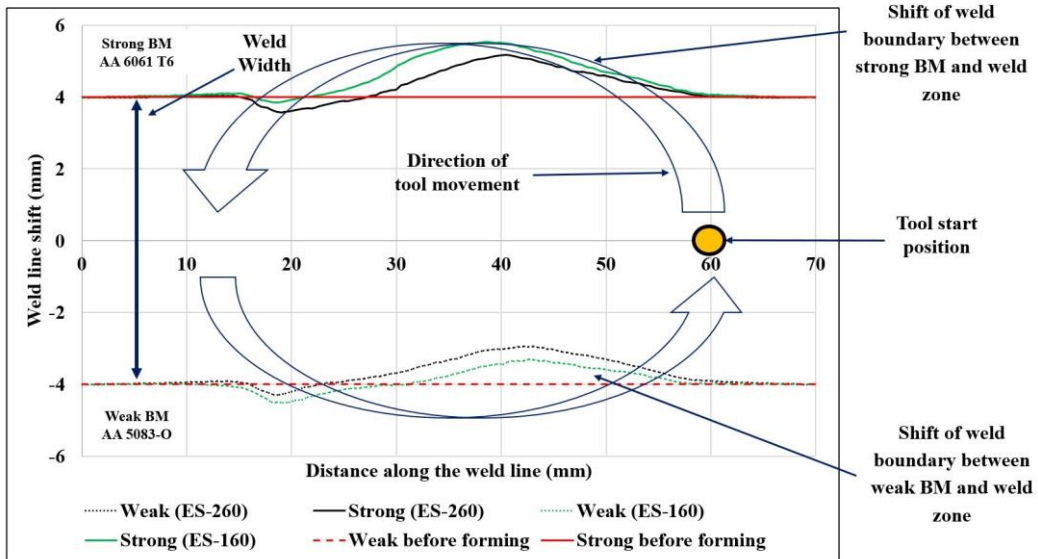

Fig. 7. Comparison of weld width and weld line shift in ES 160 and ES 260 cases

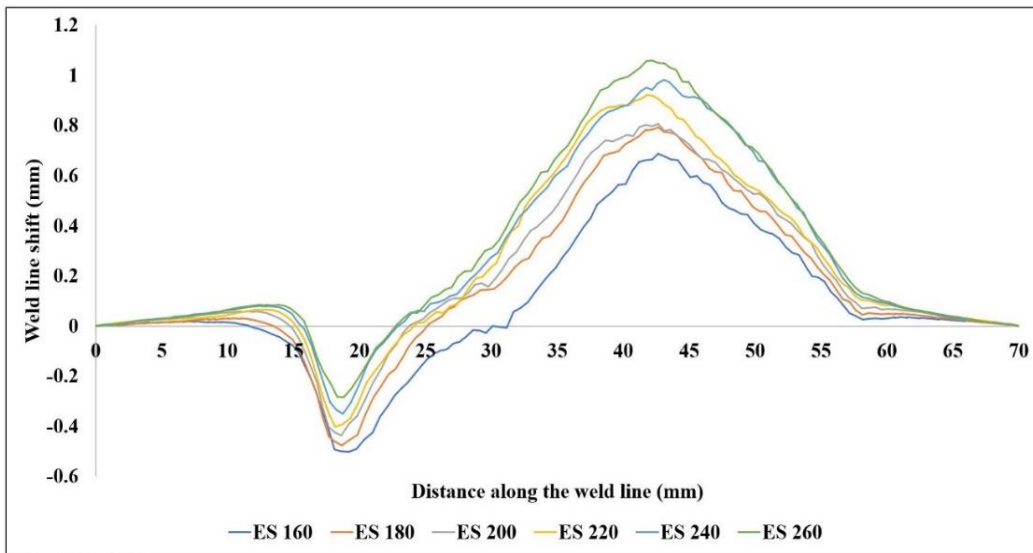

Fig. 8. Shift of boundary between weak and weld material

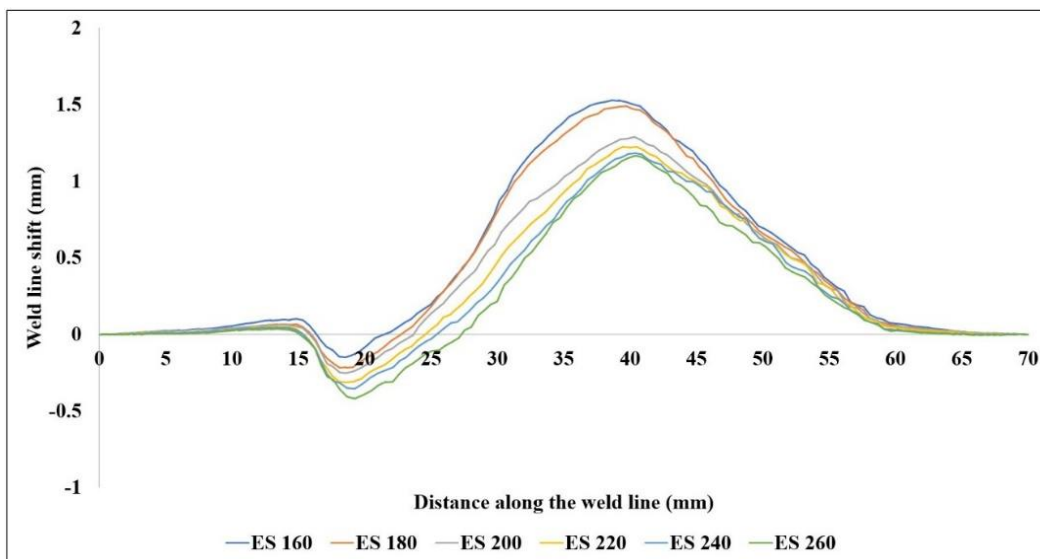

Fig. 9. Shift of boundary between strong and weld material

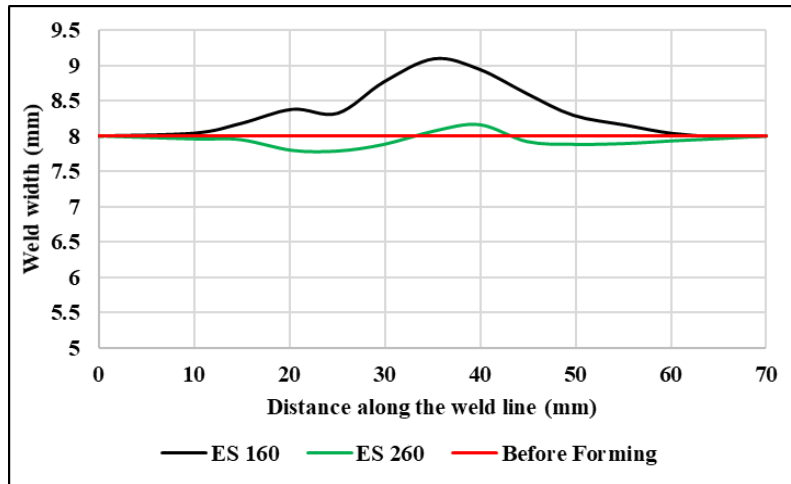

Fig. 10. Change of weld width in ES 260 and ES 160 cases

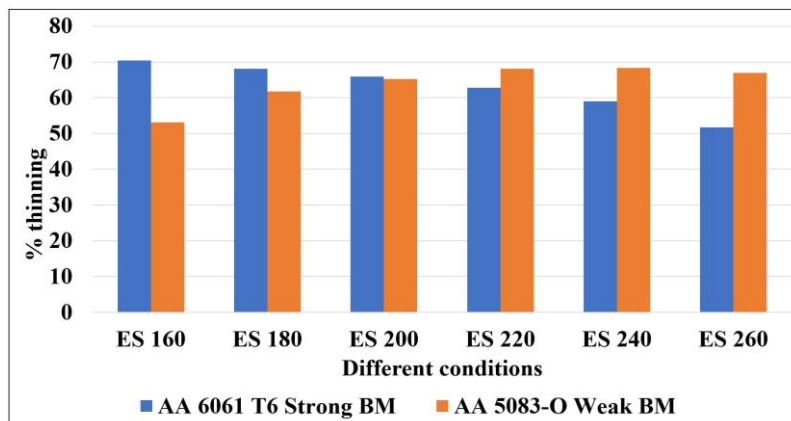

Fig. 11. % thinning for different yield strength of the weld material

In addition to the weld line shift, % thinning of blanks was also studied for different yield strength of the weld material and the results are shown in Figure 11. It indicates that as the yield strength of the weld material increases % thinning in the weak base material increases and % thinning of strong material decreases. Hence, the shift in the boundary between weld and weak material increases and shift in boundary weld and strong material decreases as the yield strength of material increases. The thickness distribution in formed TWB for ES-260 condition is shown in Figure 12.

The thinning is observed near points P and Q. The thinning at point P is at the boundary between weld and weak material due to the change in strength of weld and weak material. The weak material in section A is subjected to more thinning (Point-Q) in comparison to the weak material in section B. More thinning indicates more deformation of weak material which will result in more shift of weld line towards strong material.

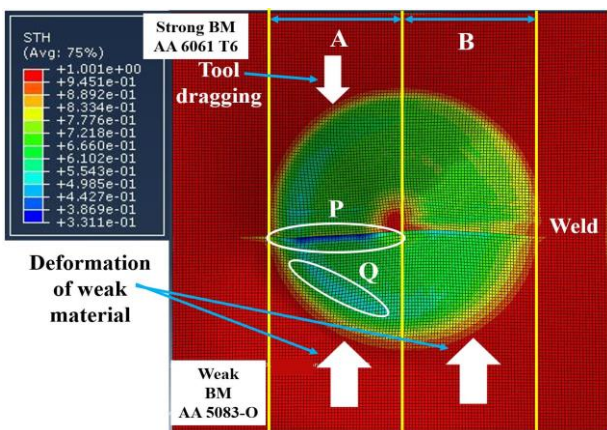

Fig. 12. Thickness distribution in the formed TWB (ES-260 condition)

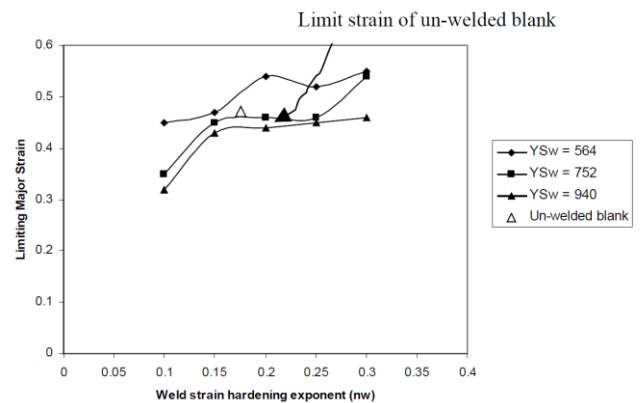

Fig. 13. Variation of limiting major strain with weld strain hardening exponent- n_w and Yield strength of weld material- YS_w in TWB (YS_w in MPa) (Narayan and Narsimhan, 2007)

But, in section A, the deformation of weak material is opposed by tool dragging resulting in to low weld line shift. In section B, there is no dragging effect which will oppose the weld line shift because of that more weld line shift is observed in section B. In addition to that the deformation experienced by weak material is more in comparison the weld material because the strength of weak material is low in comparison to the weld material.

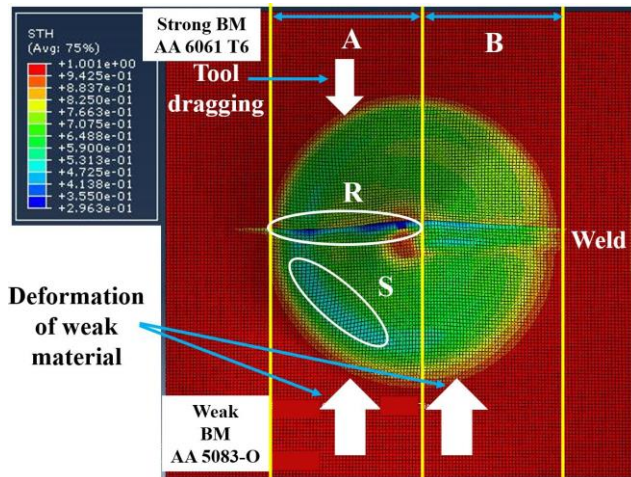

Fig. 14. Thickness distribution in the formed TWB (ES-160 condition)

Narayanan and Narasimhan, 2007 also reported that as the weld yield strength increases, the strain in the weld decreases as shown in Figure 13. It can be observed that for constant strain hardening index of weld, as the yield strength of the weld material increases, the strain experienced by the material decreases.

The thickness distribution in TWB for ES-160 condition is shown in Figure 14. It can be observed that deformation experienced by weld material is more in comparison to the weak material. Similar to ES-260 case, in section A, tool dragging and deformation weak material are opposite to each other and because of that the weld line shift in section A is less in comparison to section B. The thinning at the boundary of weak and weld material is less because the different in yield strength of weld and weak material is less in ES-160 condition.

3.3 Forming Force

During the simulation study in ABAQUS/Explicit, the forming force exerted on the forming tool in the Z-direction is recorded. The comparison of forming force for different yield strength of weld material is depicted in Figure 15. More forming force is observed for ES-260 case in comparison to all other cases. In ES-260 condition, the overall strength of TWB is more in comparison to the all-other cases resulting in to the higher forming force to form the TWBs. Similarly, for ES-160 condition, the overall strength of the TWB is lowest in comparison to all other cases hence low forming force is required to form the TWB. In the initial stage of forming, the forming force required is high in magnitude but as the process continues, the requirement of force remains almost constant. After reaching forming height of 10 mm the requirement of forming force remains constant. Similar nature of forming force was observed by Arfa et al. (2013) during simulation and experimental forming of aluminium sheet using SPIF process.

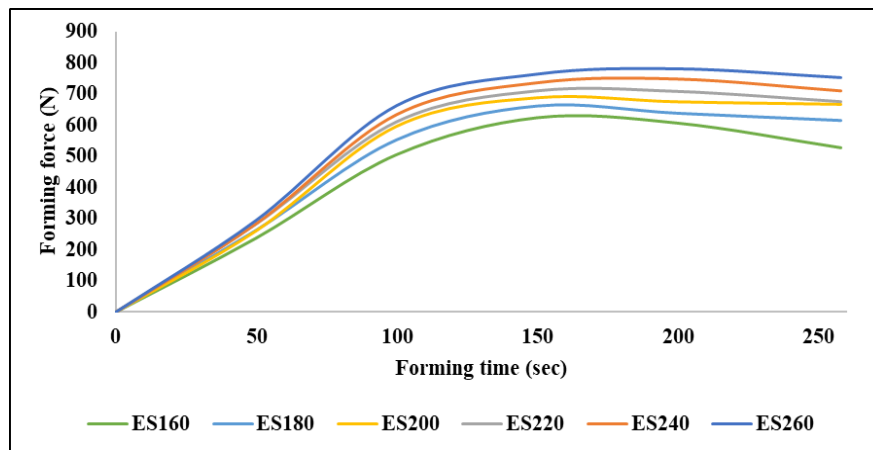

Fig. 15. Forming force comparison for different weld yield strength of weld material

4. CONCLUSIONS

In the present work, simulation of SPIF process is performed in which forming of TWBs is done. TWBs having different yield strength of weld material are considered and its effect on weld line shift and thinning of blanks is considered. Following

are the conclusion drawn from the present investigation.

During forming of TWBs during conventional forming, the weld line shift is observed towards only strong material. The nature of weld line shift observed during SPIF of TWBs is different from the weld line shift observed during conventional

forming of TWBs.

It has been found that tool dragging play significant role in weld line shift for forming of TWBs during SPIF process. The amount of weld line shift depends upon the direction of tool dragging and deformation of weak material. The deformation of weak material in the wall of the cup is opposed by tool dragging resulting in to the low weld line shift. If the deformation of weak material is not opposed, then it results in to the maximum weld line shift.

In the present investigation the effect of yield strength of weld material on weld boundary shift has also been investigated. It has been observed that as the yield strength of the weld material increases, the deformation of weak material increases leading to more thinning of weak material and more shift of boundary between weld and weak material. For TWBs, having low strength of weld material, excessive deformation is observed in weld material leading more shift in boundary between strong and weak material. This will also lead to more deformation of weld area resulting in to the increased weld width of the weld area after forming process. The increase in the yield strength of the weld material increases the requirement of force to form the TWBs.

5. REFERENCES

1. Alinaghian, I., Ranjbar, H. and Beheshtizad, M.A., (2017). *Forming limit investigation of aa6061 friction stir welded blank in a single point incremental forming process: RSM approach*. Transactions of the Indian Institute of Metals, **70**(9), pp. 2303-2318.
2. Ambrogio, G., Cozza, V., Filice, L. and Micari, F., (2007). *An analytical model for improving precision in single point incremental forming*. Journal of Materials Processing Technology, **191**(1-3), pp. 92-95.
3. Arfa, H., Bahloul, R. and BelHadjSalah, H., (2013). *Finite element modelling and experimental investigation of single point incremental forming process of aluminum sheets: influence of process parameters on punch force monitoring and on mechanical and geometrical quality of parts*. International journal of material forming, **6**(4), pp. 483-510.
4. Bansal, A., Lingam, R., Yadav, S.K. and Reddy, N.V., (2017). *Prediction of forming forces in single point incremental forming*. Journal of Manufacturing Processes, **28**, pp. 486-493.
5. Centeno, G., Bagudanch, I., Martínez-Donaire, A.J., Garcia-Romeu, M.L. and Vallellano, C., (2014). *Critical analysis of necking and fracture limit strains and forming forces in single-point incremental forming*. Materials & Design, **63**, pp. 20-29.
6. Dakhli, M., Boulila, A., Manach, P.Y. and Tourki, Z., (2019). *Optimization of processing parameters and surface roughness of metallic sheets plastically deformed by incremental forming process*. The International Journal of Advanced Manufacturing Technology, **102**(1-4), pp. 977-990.
7. Desai, B.V., Desai, K.P. and Raval, H.K., (2014). *Die-Less rapid prototyping process: Parametric investigations*. Procedia materials science, **6**, pp. 666-673.
8. Desai, B.V., Desai, K.P. and Raval, H.K., (2017). *The performance of tool shape on efficiency and quality of forming in incremental sheet-forming process*. International Journal of Rapid Manufacturing, **6**(4), pp. 215-234.
9. Kilani, L., Mabrouki, T., Ayadi, M., Chermiti, H. and Belhadi, S., (2020). *Effects of rolling ball tool parameters on roughness, sheet thinning, and forming force generated during SPIF process*. The International Journal of Advanced Manufacturing Technology, **106**(9-10), pp. 4123-4142.
10. Kumar, T.S. and Reddy, A.C., (2016). *Single Point Incremental Forming and Significance of Its Process Parameters on Formability of Conical Cups Fabricated from Aa1100-H18 Alloy*. International Journal of Engineering Inventions, **5**(6), pp. 10-18.
11. Marathe, S.P. and Raval, H.K., (2019). *Numerical investigation on forming behavior of friction stir tailor welded blanks (FSTWBs) during single-point incremental forming (SPIF) process*. Journal of the Brazilian Society of Mechanical Sciences and Engineering, **41**(10), p. 424.
12. Martins, P.A.F., Bay, N., Skjødt, M. and Silva, M.B., (2008). *Theory of single point incremental forming*. CIRP annals, **57**(1), pp. 247-252.
13. Narayanan, R.G. and Narasimhan, K., (2007). *Relative Effect of Material and Geometric Parameters on the Forming Behaviour of Tailor Welded Blanks*. International Journal of Forming Processes, **10**(2), pp. 145.
14. Parente, M., Safdarian, R., Santos, A.D., Loureiro, A., Vilaca, P. and Jorge, R.N., (2016). *A study on the formability of aluminum tailor welded blanks produced by friction stir welding*. The International Journal of Advanced Manufacturing Technology, **83**(9-12), pp. 2129-2141.
15. Rattanachan, K., Sirivedin, K. and Chungchoo, C., (2014). *Formability of Tailored Welded Blanks in Single Point Incremental Forming Process*. In Advanced Materials Research. **979**, pp. 339-342.
16. Silva, M.B., Nielsen, P.S., Bay, N. and Martins, P.A.F., (2011). *Failure mechanisms in single-point incremental forming of metals*. The International Journal of Advanced Manufacturing Technology, **56**(9-12), pp. 893-903.

17. Silva, M.B., Skjødt, M., Vilaça, P., Bay, N. and Martins, P.A.F., (2009). *Single point incremental forming of tailored blanks produced by friction stir welding*. Journal of Materials Processing Technology, **209**(2), pp. 811-820.
18. Suresh, V.S., Regalla, S.P. and Gupta, A.K., (2016). *Combined effect of thickness ratio and selective heating on weld line movement in stamped tailor-welded blanks*. Materials and Manufacturing Processes, pp.1-5.
19. Tayebi, P., Fazli, A., Asadi, P. and Soltanpour, M., (2019). *Formability analysis of dissimilar friction stir welded AA 6061 and AA 5083 blanks by SPIF process*. CIRP Journal of Manufacturing Science and Technology, **25**, pp. 50-68.
20. Zadpoor, A.A., Sinke, J. and Benedictus, R., (2007). *Mechanics of tailor welded blanks: an overview*. In Key Engineering Materials. **344**, pp. 373-382.
21. Zhang, Q., Xiao, F., Guo, H., Li, C., Gao, L., Guo, X., Han, W. and Bondarev, A.B., (2010). *Warm negative incremental forming of magnesium alloy AZ31 Sheet: New lubricating method*. Journal of Materials Processing Technology, **210**(2), pp. 323-329.